

metabo

PICK+MIX

Einfach clever kombiniert.

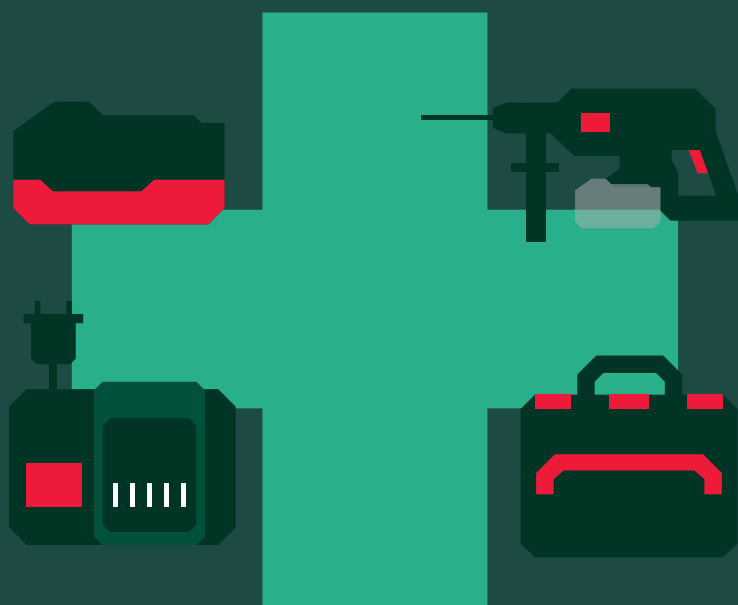

18V

April 2025



the swiss
edition.

1. Akku, Ladegerät oder Basis-Set auswählen

Batterien und Basis-Sets

NEW



	4.0 Ah LiHD Xtreme	8.0 Ah LiHD Xtreme
	LiHDX	LiHDX
Bestell-Nr.	624974000	624975000
Lieferumfang	1 x Batterie Karton	1 x Batterie Karton
vRG inkl. MwSt	0.86	1.73
Preis inkl. MwSt/vRG	129.00	189.00
Bestell-Nr.	685306000	685305180
Lieferumfang	2 x Batterien	2 x Batterien
metaBOX	ASC 145	ASC 290
vRG inkl. MwSt	2.33	2.33
Preis inkl. MwSt/vRG	339.00	489.00

NEW



Das ultimative Level

Mit der neuen LiHDX Technologie für Heavy Duty Work setzen wir in puncto Performance, Lauf- und Ladezeiten neue Maßstäbe. So sehen die Leistungssteigerungen konkret im Vergleich aus.

**Bis zu
100 % mehr
Performance¹**



+100%

**Bis zu
85 % mehr
Laufzeit¹**



+85%

**Doppelt
so schnell
geladen²**



×2

(1) in bestimmten Heavy-Duty-Anwendungen; durch geringere Hitzeentwicklung im Inneren der Akkupacks im Vergleich zu LiHD 8.0 Ah

(2) LiHDX mit ASC 290 im Vergleich zum heutigen Standard: LiHD 8.0 Ah und ASC 145

PICK+MIX 18V

Batterien und Basis-Sets



	4.0 Ah LiHD	5.5 Ah LiHD	8.0 Ah LiHD	10.0 Ah LiHD
	HD	HD	HD	HD
Bestell-Nr.	625367000	625368000	625369000	625549000
Lieferumfang	1 x Batterie Karton	1 x Batterie Karton	1 x Batterie Karton	1 x Batterie Karton
vRG inkl. MwSt	0.86	0.86	1.73	1.73
Preis inkl. MwSt/vRG	109.00	129.00	149.00	169.00
Bestell-Nr.	624989000	624990000		624991000
Lieferumfang	1 x Batterie	1 x Batterie		1 x Batterie
Karton	mit Sicherheitsbügel	mit Sicherheitsbügel		mit Sicherheitsbügel
vRG inkl. MwSt	0.86	0.86		1.73
Preis inkl. MwSt/vRG	115.00	135.00		175.00
Bestell-Nr.	685163000	685122000		
Lieferumfang	2 x Batterien	2 x Batterien		
metaBOX	ASC 55	ASC 145		
vRG inkl. MwSt	2.33	2.33		
Preis inkl. MwSt/vRG	229.00	279.00		
Bestell-Nr.	685160000		685303180	685304180
Lieferumfang	1 x 4.0 Ah + 1 x 5.5 Ah		2 x Batterien	2 x Batterien
metaBOX	ASC 55		ASC 290	ASC 290
vRG inkl. MwSt	2.33		2.33	2.33
Preis inkl. MwSt/vRG	269.00		429.00	479.00
Bestell-Nr.	685132000	685074000		
Lieferumfang	3 x Batterien	3 x Batterien		
Karton	ASC 55	ASC 145		
vRG inkl. MwSt	2.33	2.33		
Preis inkl. MwSt/vRG	309.00	409.00		
Bestell-Nr.			685135000	685143000
Lieferumfang			4 x Batterien	4 x Batterien
metaBOX			ASC 145 DUO	ASC 145 DUO
vRG inkl. MwSt			2.33	5.96
Preis inkl. MwSt/vRG			699.00	819.00

CAS

Li HD



3 YEARS WARRANTY

1. Akku, Ladegerät oder Basis-Set auswählen

Batterien und Basis-Sets



	2.0 Ah LiPower	4.0 Ah LiPower	5.2 Ah LiPower
	Li POWER	Li POWER	Li POWER
Bestell-Nr.	625026000	625027000	625028000
Lieferumfang	1 x Batterie Karton	1 x Batterie Karton	1 x Batterie Karton
vRG inkl. MwSt	0.86	0.86	0.86
Preis inkl. MwSt/vRG	69.00	99.00	119.00
Bestell-Nr.		685192000	
Lieferumfang		1 x Batterie	
Karton		SC30	
vRG inkl. MwSt		1.58	
Preis inkl. MwSt/vRG		119.00	
Bestell-Nr.	685161000	685050000	685051000
Lieferumfang	2 x Batterien	2 x Batterien	2 x Batterien
Karton	SC 30	ASC 55	ASC 145
vRG inkl. MwSt	2.33	2.33	2.33
Preis inkl. MwSt/vRG	129.00	199.00	249.00



100 % kompatibel

zu allen Maschinen und Ladegeräten von Metabo und CAS-Partnern



3 Jahre Akkupack-Garantie

ohne Beschränkung der Ladezyklen

PICK+MIX 18V

Ladegeräte



	Ladegerät ASC 55	Schnell-Ladegerät ASC 145	Schnell-Ladegerät ASC 290
Bestell-Nr.	627044000	627378000	627376000
vRG inkl. MwSt	0.61	0.61	0.61
Preis inkl. MwSt/vRG	55.00	85.00	129.00



	Doppel- Schnellladegerät ASC 145 DUO	Schnellladestation ASC 55 multi 8
Bestell-Nr.	627495000	627093000
vRG inkl. MwSt	0.61	2.50
Preis inkl. MwSt/vRG	165.00	699.00

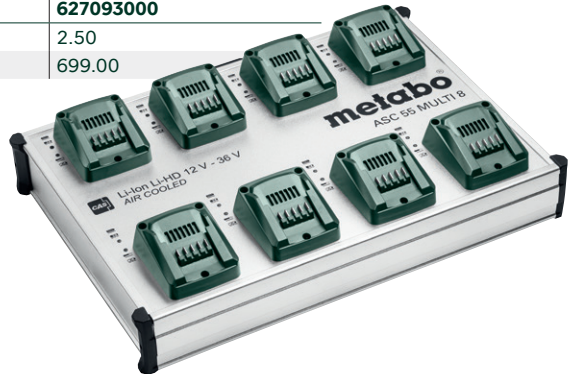

AKKU-ZUBEHÖR

2. Maschine auswählen

Bohren / Schrauben



	Bohrschrauber BS 18 L BL	Bohrschrauber BS 18 L BL Q	Bohrschrauber BS 18 LT BL
	BRUSHLESS	BRUSHLESS	BRUSHLESS
Technische Daten	L	L, Quick	LT
Drehmoment hart	60 Nm	65 Nm	75 Nm
Leerlaufdrehzahlen	0 - 550 / 0 - 1'850 /min	0 - 500 / 0 - 1'700 /min	0 - 600 / 0 - 2'100 /min
Service Gruppe	H01=69.00 / FS2=109.00	H02=135.00 / FS2=109.00	H02=135.00 / FS3=159.00
Bestell-Nr.	613155850	613156850	602325890
Verpackung	Karton	Karton	Karton
vRG inkl. MwSt	0.61	0.61	0.61
Preis inkl. MwSt/vRG	175.00	205.00	215.00
Bestell-Nr.	613155840	613156840	602325840
Verpackung	metaBOX	metaBOX	metaBOX
vRG inkl. MwSt	0.61	0.61	0.61
Preis inkl. MwSt/vRG	189.00	219.00	229.00



	Bohrschrauber BS 18 LT BL Q	Bohrschrauber BS 18 LTX BL I	Bohrschrauber BS 18 LTX BL Q I
	BRUSHLESS	BRUSHLESS	BRUSHLESS
Technische Daten	LT, Quick	LTX	LTX, Quick
Drehmoment hart	75 Nm	130 Nm	130 Nm
Leerlaufdrehzahlen	0 - 600 / 0 - 2'100 /min	0 - 550 / 0 - 2'000 /min	0 - 550 / 0 - 2'000 /min
Service Gruppe	H02=135.00 / FS4=215.00	H02=135.00 / FS3=159.00	H02=135.00 / FS4=215.00
Bestell-Nr.	602334890	602358850	602359850
Verpackung	Karton	Karton	Karton
vRG inkl. MwSt	0.61	0.61	0.61
Preis inkl. MwSt/vRG	245.00	285.00	315.00
Bestell-Nr.	602334840	602358840	602359840
Verpackung	metaBOX	metaBOX	metaBOX
vRG inkl. MwSt	0.61	0.61	0.61
Preis inkl. MwSt/vRG	259.00	299.00	329.00

Bohren / Schrauben



**3-Gang-Bohrschrauber
BS 18 LTX-3 BL Q I**

BRUSHLESS

Technische Daten	LTX, Quick plus
Drehmoment hart	130 Nm
Leerlaufdrehzahlen	0-450 /min / 0-2.000/min / 0-4.000/min
Service Gruppe	H02=135.00 / FS4=215.00
Bestell-Nr.	603184850

**3-Gang-Bohrschrauber
BS 18 LTX-3 BL I metal**

BRUSHLESS

Technische Daten	LTX, Metall
Drehmoment hart	130 Nm
Leerlaufdrehzahlen	0-450 /min / 0-2.000/min / 0-4.000/min
Service Gruppe	H02=135.00 / FS4=215.00
Bestell-Nr.	603181850

**3-Gang-Bohrschrauber
BS 18 LTX-3 BL Q I metal**

BRUSHLESS

Technische Daten	LTX, Metall - Quick plus
Drehmoment hart	130 Nm
Leerlaufdrehzahlen	0-450 /min / 0-2.000/min / 0-4.000/min
Service Gruppe	H02=135.00 / FS4=215.00
Bestell-Nr.	603180850

Verpackung	Karton
vRG inkl. MwSt	0.61
Preis inkl. MwSt/vRG	345.00
Bestell-Nr.	603184840
Verpackung	metaBOX
vRG inkl. MwSt	0.61
Preis inkl. MwSt/vRG	359.00

Verpackung	Karton
vRG inkl. MwSt	0.61
Preis inkl. MwSt/vRG	365.00
Bestell-Nr.	603181840
Verpackung	metaBOX
vRG inkl. MwSt	0.61
Preis inkl. MwSt/vRG	389.00

Verpackung	Karton
vRG inkl. MwSt	0.61
Preis inkl. MwSt/vRG	395.00
Bestell-Nr.	603180840
Verpackung	metaBOX
vRG inkl. MwSt	0.61
Preis inkl. MwSt/vRG	419.00



**Gewindebohrer
GB 18 LTX BL Q I**

BRUSHLESS

Technische Daten	LTX, Quick
Drehmoment hart	130 Nm
	Gewindebohrer, 2 x Bohrfutter
Service Gruppe	H02=135.00 / FS4=215.00
Bestell-Nr.	602362850
Verpackung	Karton
vRG inkl. MwSt	0.61
Preis inkl. MwSt/vRG	435.00
Bestell-Nr.	602362840
Verpackung	metaBOX
vRG inkl. MwSt	0.61
Preis inkl. MwSt/vRG	449.00



AKKU-MASCHINEN

2. Maschine auswählen

Schlagbohren / Schrauben



	Schlagbohrschrauber SB 18 LT BL	Schlagbohrschrauber SB 18 LTX BL Q I	3-Gang- Schlagbohrschrauber SB 18 LTX-3 BL Q I
	BRUSHLESS	BRUSHLESS	BRUSHLESS
Technische Daten	LT	LTX, Quick	LTX, Quick plus
Drehmoment hart	75 Nm	130 Nm	130 Nm
Leerlaufdrehzahlen	0 - 600 / 0 - 2'100 /min	0 - 550 / 0 - 2'000 /min	0-450 /min / 0-2.000/min /0-4.000/min
Service Gruppe	H02=135.00 / FS3=159.00	H02=135.00 / FS4=215.00	H02=135.00 / FS4=215.00
Bestell-Nr.	602316890	602361850	603185850
Verpackung	Karton	Karton	Karton
vRG inkl. MwSt	0.61	0.61	0.61
Preis inkl. MwSt/vRG	215.00	315.00	345.00
Bestell-Nr.	602316840	602361840	603185840
Verpackung	metaBOX	metaBOX	metaBOX
vRG inkl. MwSt	0.61	0.61	0.61
Preis inkl. MwSt/vRG	229.00	329.00	359.00



**3-Gang-
Schlagbohrschrauber
SB 18 LTX-3 BL Q I metal**

	BRUSHLESS
Technische Daten	LTX, Metall, Quick plus
Drehmoment hart	130 Nm
Leerlaufdrehzahlen	0-450 /min / 0-2.000/min /0-4.000/min
Service Gruppe	H02=135.00 / FS4=215.00
Bestell-Nr.	603182850
Verpackung	Karton
vRG inkl. MwSt	0.61
Preis inkl. MwSt/vRG	395.00
Bestell-Nr.	603182840
Verpackung	metaBOX
vRG inkl. MwSt	0.61
Preis inkl. MwSt/vRG	419.00



AKKU-MASCHINEN

m
SERVICE

Einfach sicher mit den Metabo Services.

XXL

Immer kostenlos – 3 Jahre Garantie auf alle Metabo Geräte, mit nur einer einfachen Registrierung.

FULL

Das Rund-um-Sorglospaket umfasst auch Verschleissreparaturen. Einfach mit einem Full Service Code – erhältlich ab CHF 55.00 – upgraden und zusätzlich von weiteren Vorteilen profitieren.*

m
SERVICE

XXL

FULL

INDIVIDUAL

Laufzeit 3 Jahre	✓	✓	1-3 Jahre
Garantie auf Material und Herstellfehler**	✓	✓	✓
Akku- und Ladegerät inkludiert	✓	✓	✓
Kostenlose Verschleissreparaturen		✓	✓
Absicherung bei Diebstahl		✓	✓
Individuelle Beratung, Maschinen und Preise			✓
RFID			✓

* Bei LiHD-Partnern ist der Full Service für Akkumaschinen kostenlos. Dies erfolgt automatisch durch die Registrierung.

** Der Garantienehmer hat unbeschadet dieser Garantien die gesetzlichen Rechte des Käufers, insbesondere Gewährleistungsrechte oder Produkthaftung. Nähere Infos unter metabo.ch/garantierklaerung

Effizientes und flexibles Arbeiten

- ✓ Vielseitig und komfortabel
- ✓ Sekundenschnell zwischen Bohren und Schrauben wechseln
- ✓ Werkzeuglos



Das Quick-System für alle L, LT und LTX Bohr-schrauber und Schlagbohrschrauber mit dem Zusatz »Quick«. Die Werkzeugaufnahmen sind für die Leistungsklassen und Einsatzbereiche der jeweiligen Maschinen ausgelegt.



Das neue QuickPlus-System für die neuen LTX-3-Gang-Bohrschrauber und -Schlagbohrschrauber mit dem Zusatz »Quick«. Die Werkzeugaufnahmen sind konzipiert für extrem harte Anwendungen mit besonders hohen Drehmomenten.

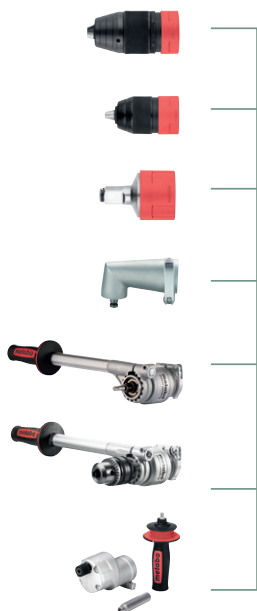

LTX-3 + LTX + BE 75



Schnellwechselbohrfutter
Futuro Top R+L »QuickPlus«
Bestell-Nr. 627197000



Schnellwechselbohrfutter
Futuro Plus S1 M »QuickPlus«
Bestell-Nr. 627189000

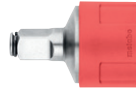

Schnellwechselhalter
für Bits und Steckschlüssel »QuickPlus«
Bestell-Nr. 627341000

LTX-3 + LTX + BE 75

Schnellwechselwinkel-
adapter »Quick«
Bestell-Nr. 627242000



Drehmomentvorsatz
PowerX3
Bestell-Nr. 627256000



Exzenteraufsatz
»Quick«
Bestell-Nr. 627343000



Drehmomentvorsatz
PowerX3 DC
Bestell-Nr. 627232000



LT + LTX + BE 75



Schnellwechselbohr-
futter Futuro Plus S 1 M,
»Quick«
Bestell-Nr. 627240000



Schnellwechselbohrfutter
Futuro Plus S 1 M/HM,
»Quick«
Bestell-Nr. 627203000



NUR LT!
Schnellwechselwinkel-
adapter »Quick«
Bestell-Nr. 627077000



Schnellwechselzahn-
kranzbohrfutter
»Quick«
Bestell-Nr. 627238000



Schnellwechsel-
gewindebohrfutter
M4-M6 627235000
M8-M12 627237000
(nur für Gewindebohrer)



Schnellwechsel-
bithalter »Quick«
Bestell-Nr. 627241000

L+ POWERMAXX



Schnellwechselbohrfutter
Futuro Plus H 1 R+L, »Quick«
Bestell-Nr. 627259000



Schnellwechsel-
bithalter »Quick«
Bestell-Nr. 627241000



Schnellwechselwinkel-
adapter »Quick«
Bestell-Nr. 627261000



Exzenteraufsatz
»Quick«
Bestell-Nr. 627234000

2. Maschine auswählen

Hammerbohren, Bohren und Meisseln



	Bohrhammer BH 18 LTX BL 16	Kombihammer KH 18 LTX 24	Kombihammer KH 18 LTX BL 24
	BRUSHLESS		BRUSHLESS
Technische Daten	LTX SDS-plus, L-Shape form Opt. Ø 4 - 8 mm, 1,3 J	LTX SDS-plus, L-Shape form Opt. Ø 6 - 14 mm, 2,1 J	LTX SDS-plus, L-Shape form Opt. Ø 6 - 14 mm, 2,2 J
Service Gruppe	H02=135.00 / FS3=159.00	H02=135.00 / FS3=159.00	H02=135.00 / FS3=159.00
Bestell-Nr.	600324850	601712850	601713850
Verpackung	Karton	Karton	Karton
vRG inkl. MwSt	0.61	0.61	0.61
Preis inkl. MwSt/vRG	249.00	235.00	335.00
Bestell-Nr.	600324840	601712840	601713840
Verpackung	metaBOX	metaBOX	metaBOX
vRG inkl. MwSt	0.61	0.61	0.61
Preis inkl. MwSt/vRG	269.00	249.00	349.00



	Kombihammer KH 18 LTX BL 24 Q	Kombihammer KH 18 LTX BL 28 Q
	BRUSHLESS	BRUSHLESS
Technische Daten	LTX Quick / SDS-plus, L-Shape form Opt. Ø 6 - 14 mm, 2,2 J	LTX Quick / SDS-plus, L-Shape form Opt. Ø 8 - 18 mm, 3 J
Service Gruppe	H02=135.00 / FS3=159.00	H02=135.00 / FS3=159.00
Bestell-Nr.	601714850	601715850
Verpackung	Karton	Karton
vRG inkl. MwSt	0.61	0.61
Preis inkl. MwSt/vRG	375.00	395.00
Bestell-Nr.	601714840	601715840
Verpackung	metaBOX	metaBOX
vRG inkl. MwSt	0.61	0.61
Preis inkl. MwSt/vRG	399.00	419.00

PICK+MIX 18V

Hammerbohren, Bohren und Meisseln



NEW



	Kombihammer KH 18 LTX BL 35 Q	Kombihammer KHA 18 LTX BL 40
	BRUSHLESS	BRUSHLESS
Technische Daten	LTX Quick / SDS-plus, L-Shape form 32 mm, 4,2 J	LTX SDS-max, L-Shape form Opt. Ø 14 - 30 mm, 8,6 J
Service Gruppe	H03=189.00 / FS4=215.00	H03=189.00 / FS4=215.00
Bestell-Nr.	600813850	
Verpackung	Karton	
vRG inkl. MwSt	2.50	
Preis inkl. MwSt/vRG	645.00	
Bestell-Nr.	600813840	600752840
Verpackung	metaBOX	Koffer
vRG inkl. MwSt	2.50	2.50
Preis inkl. MwSt/vRG	689.00	669.00

Absaugung



	Absaugung ISA 24	Absaugung ISA 28	Absaugung ESA Plus
Technische Daten	Bohrer Ø 5 - 16 mm für KH 18 LTX BL 24 Q	Bohrer Ø 5 - 16 mm für KH 18 LTX BL 28 Q	Bohrer Ø 5 - 32 mm für Hämmer SDS-plus
Service Gruppe	H01=69.00 / FS2=109.00	H01=69.00 / FS2=109.00	Keine
Bestell-Nr.	631357850	631358850	623770000
Verpackung	Karton	Karton	Karton
vRG inkl. MwSt	0.61	0.61	
Preis inkl. MwSt/vRG	179.00	179.00	28.00

2. Maschine auswählen

Schlagschrauben



**Schlagschrauber
SSD 18 LTX 200 BL**

BRUSHLESS

Technische Daten	LTX
Dreh-/Lösemoment	200 Nm
Werkzeugaufnahme	Innensechskant 1/4"
Service Gruppe	H02=135.00 / FS4=215.00
Bestell-Nr.	602396890



**Schlagschrauber
SSW 18 LT 300 BL**

BRUSHLESS

Technische Daten	LT
Dreh-/Lösemoment	300 Nm / 480 Nm
Werkzeugaufnahme	Aussenvierkant 1/2"
Service Gruppe	H01=69.00 / FS4=215.00
Bestell-Nr.	602398850



**Schlagschrauber
SSW 18 LTX 300 BL**

BRUSHLESS

Technische Daten	LTX
Dreh-/Lösemoment	300 Nm / 480 Nm
Werkzeugaufnahme	Aussenvierkant 1/2"
Service Gruppe	H02=135.00 / FS4=215.00
Bestell-Nr.	602395890

Verpackung	Karton	Karton	Karton
vRG inkl. MwSt	0.61	0.61	0.61
Preis inkl. MwSt/vRG	255.00	195.00	285.00
Bestell-Nr.	602396840	602398840	602395840
Verpackung	metaBOX	metaBOX	metaBOX
vRG inkl. MwSt	0.61	0.61	0.61
Preis inkl. MwSt/vRG	269.00	209.00	299.00



**Schlagschrauber
SSW 18 LTX 400 BL**

BRUSHLESS

Technische Daten	LTX
Dreh-/Lösemoment	400 Nm / 620 Nm
Werkzeugaufnahme	Aussenvierkant 1/2"
Service Gruppe	H02=135.00 / FS4=215.00
Bestell-Nr.	602205890



**Schlagschrauber
SSW 18 LTX 800 BL**

BRUSHLESS

Technische Daten	LTX
Dreh-/Lösemoment	800 Nm / 1'200 Nm
Werkzeugaufnahme	Aussenvierkant 1/2"
Service Gruppe	H02=135.00 / FS3=159.00
Bestell-Nr.	602403850



**Schlagschrauber
SSW 18 LTX 1450 BL**

BRUSHLESS

Technische Daten	LTX
Dreh-/Lösemoment	1'450 Nm / 1'900 Nm
Werkzeugaufnahme	Aussenvierkant 1/2"
Service Gruppe	H02=135.00 / FS4=215.00
Bestell-Nr.	602401850

Verpackung	Karton	Karton	Karton
vRG inkl. MwSt	0.61	0.61	0.61
Preis inkl. MwSt/vRG	315.00	365.00	435.00
Bestell-Nr.	602205840	602403840	602401840
Verpackung	metaBOX	metaBOX	metaBOX
vRG inkl. MwSt	0.61	0.61	0.61
Preis inkl. MwSt/vRG	329.00	389.00	459.00

Schlagschrauben

Schlagschrauber SSW 18 LTX 1750 BL

BRUSHLESS

Technische Daten	LTX
Dreh-/Lösemoment	1'750 Nm / 2'100 Nm
Werkzeugaufnahme	Aussenvierkant 3/4"
Service Gruppe	H02=135.00 / FS4=215.00
Bestell-Nr.	602402850
Verpackung	Karton
vRG inkl. MwSt	0.61
Preis inkl. MwSt/vRG	465.00
Bestell-Nr.	602402840
Verpackung	metaBOX
vRG inkl. MwSt	0.61
Preis inkl. MwSt/vRG	489.00



AKKU-MASCHINEN

2. Maschine auswählen

Trennen / Schleifen



	Winkelschleifer CC 18 LTX BL	Winkelschleifer W 18 7-125	Winkelschleifer W 18 L 9-125
	BRUSHLESS		
Technische Daten	LTX		L
Scheiben-Ø	76 mm	125 mm	125 mm
Leerlaufdrehzahl	20'000 U/min	8'500 U/min	8'500 U/min
Service Gruppe	H01=69.00 / FS2=109.00	H01=69.00 / FS1=55.00	H01=69.00 / FS2=109.00
Bestell-Nr.	600349850	602371850	602247850
Verpackung	Karton	Karton	Karton
vRG inkl. MwSt	0.61	0.61	0.61
Preis inkl. MwSt/vRG	165.00	135.00	185.00
Bestell-Nr.	600349840	602371840	602247840
Verpackung	metaBOX	metaBOX	metaBOX
vRG inkl. MwSt	0.61	0.61	0.61
Preis inkl. MwSt/vRG	179.00	149.00	199.00



	Winkelschleifer W 18 L BL 9-125	Winkelschleifer WB 18 LT BL 11-125 Q	Winkelschleifer WPB 18 LT BL 11-125 Q
	BRUSHLESS	BRUSHLESS	BRUSHLESS
Technische Daten	L	LT, Quick, Bremse	LT, Quick
Scheiben-Ø	125 mm	125 mm	125 mm
Leerlaufdrehzahl	10'000 U/min	10'000 U/min	10'000 U/min, Totmannschalter
Service Gruppe	H02=135.00 / FS1=55.00	H02=135.00 / FS3=159.00	H02=135.00 / FS3=159.00
Bestell-Nr.	602374850	613054850	613059850
Verpackung	Karton	Karton	Karton
vRG inkl. MwSt	0.61	0.61	0.61
Preis inkl. MwSt/vRG	215.00	265.00	295.00
Bestell-Nr.	602374840	613054840	613059840
Verpackung	metaBOX	metaBOX	metaBOX
vRG inkl. MwSt	0.61	0.61	0.61
Preis inkl. MwSt/vRG	229.00	279.00	309.00

Trennen / Schleifen



Winkelschleifer
WVB 18 LT BL 11-125 Q

BRUSHLESS

Technische Daten	LT, Quick
Scheiben-Ø	125 mm
Leerlaufdrehzahl	2'800 - 10'000 / min
Service Gruppe	H02=135.00 / FS3=159.00
Bestell-Nr.	613057850
Verpackung	Karton
vRG inkl. MwSt	0.61
Preis inkl. MwSt/vRG	295.00
Bestell-Nr.	613057840
Verpackung	metaBOX
vRG inkl. MwSt	0.61
Preis inkl. MwSt/vRG	309.00



Winkelschleifer
WB 18 LTX BL 15-125 Q

BRUSHLESS

Technische Daten	LTX, Quick
Scheiben-Ø	125 mm
Leerlaufdrehzahl	10'000 / min
Service Gruppe	H02=135.00 / FS4=215.00
Bestell-Nr.	601730850
Verpackung	Karton
vRG inkl. MwSt	0.61
Preis inkl. MwSt/vRG	365.00
Bestell-Nr.	601730840
Verpackung	metaBOX
vRG inkl. MwSt	0.61
Preis inkl. MwSt/vRG	389.00



Winkelschleifer
WVB 18 LTX BL 15-125 Q

BRUSHLESS

Technische Daten	LTX, Quick
Scheiben-Ø	125 mm
Leerlaufdrehzahl	2'500 - 10'000 / min
Service Gruppe	H02=135.00 / FS4=215.00
Bestell-Nr.	601731850
Verpackung	Karton
vRG inkl. MwSt	0.61
Preis inkl. MwSt/vRG	395.00
Bestell-Nr.	601731840
Verpackung	metaBOX
vRG inkl. MwSt	0.61
Preis inkl. MwSt/vRG	419.00



Winkelschleifer
WPB 36-18 LTX BL 24-230 Q

BRUSHLESS

Technische Daten	LTX, Quick
Scheiben-Ø	230 mm
Leerlaufdrehzahl, Trenntiefe	6'600 U/min, 77 mm
Service Gruppe	H02/FS4
Bestell-Nr.	613103840
Verpackung	Koffer
vRG inkl. MwSt	0.61
Preis inkl. MwSt/vRG	519.00



Flachkopf-Winkelschleifer
WVBF 18 LT BL 11-125 Q

BRUSHLESS

Technische Daten	LT, Quick
Scheiben-Ø	125 mm
Leerlaufdrehzahl	2.500-9.000 / min
Service Gruppe	H02=135.00 / FS4=215.00
Bestell-Nr.	601307840
Verpackung	metaBOX
vRG inkl. MwSt	0.61
Preis inkl. MwSt/vRG	369.00



Flachkopf-Winkelschleifer
WVBF 18 LTX BL 15-125 Q

BRUSHLESS

Technische Daten	LTX, Quick
Scheiben-Ø	125 mm
Leerlaufdrehzahl	2.500-9.000 / min
Service Gruppe	H02=135.00 / FS4=215.00
Bestell-Nr.	601308840
Verpackung	metaBOX
vRG inkl. MwSt	0.61
Preis inkl. MwSt/vRG	399.00

2. Maschine auswählen

Trockenbau / Nieten



	Trockenbauschrauber HBS 18 LTX BL 3000 BRUSHLESS	Trockenbauschrauber TBS 18 LTX BL 5000 BRUSHLESS	Schrauber-Magazin Speed Fix 57
Technische Daten	LTX	LTX	für TBS+HBS
Leertauhdrehzahl	0 – 3'000 U/min	0 – 5'000 U/min	2x Bits PH 146 mm
Werkzeugaufnahme	Innensechskant 1/4" (6,35 mm)	Innensechskant 1/4" (6,35 mm)	
Service Gruppe	H02=135.00 / FS3=159.00	H02=135.00 / FS3=159.00	Keine
Bestell-Nr.	620062840	620063840	630611000
Verpackung	metaBOX	metaBOX	Karton
vRG inkl. MwSt	0.61	0.61	
Preis inkl. MwSt/vRG	289.00	289.00	121.50



	Blindnietpistole NP 18 LTX BL 5.0 BRUSHLESS	Nietmutternpistole NMP 18 LTX BL M10 BRUSHLESS
Technische Daten	LTX	LTX
	2.4-5 mm	Gerätehub 10 mm
	10'000 N Setzkraft, 25 mm Hub	Alu M 10, Stahl M 8, Edelstahl M 6
Service Gruppe	H03=189.00 / FS4=215.00	H04=269.00 / FS4=215.00
Bestell-Nr.	619002890	601788850
Verpackung	Karton	Karton
vRG inkl. MwSt	0.61	0.61
Preis inkl. MwSt/vRG	795.00	1'395.00
Bestell-Nr.	619002840	601788840
Verpackung	metaBOX	metaBOX
vRG inkl. MwSt	0.61	0.61
Preis inkl. MwSt/vRG	829.00	1'449.00

PICK+MIX 18V

Fräsen



NEW

Kantenfräse

FMV 18 LTX BL 8

BRUSHLESS

Technische Daten	LTX
Max. Hubhöhe	40 mm
Leerlaufdrehzahl	4'800 - 29'000 U/min
Spannzange	6 / 8 mm
Gewicht	1 kg
Service Gruppe	H02=135.00 / FS3=159.00
Bestell-Nr.	601742850

Verpackung	Karton
vRG inkl. MwSt	0.61
Preis inkl. MwSt/vRG	275.00
Bestell-Nr.	601742840
Verpackung	metaBOX
vRG inkl. MwSt	0.61
Preis inkl. MwSt/vRG	289.00

Oberfräse

OFV 18 LTX BL 12

BRUSHLESS

Technische Daten	LTX
Max. Hubhöhe	50 mm
Leerlaufdrehzahl	11'000 - 25'000 U/min
Spannzange	6 / 8 / 12 mm
Gewicht	2,9 kg
Service Gruppe	H02=135.00 / FS4=215.00
Bestell-Nr.	601743840

NEW

Verpackung	metaBOX
vRG inkl. MwSt	0.61
Preis inkl. MwSt/vRG	469.00

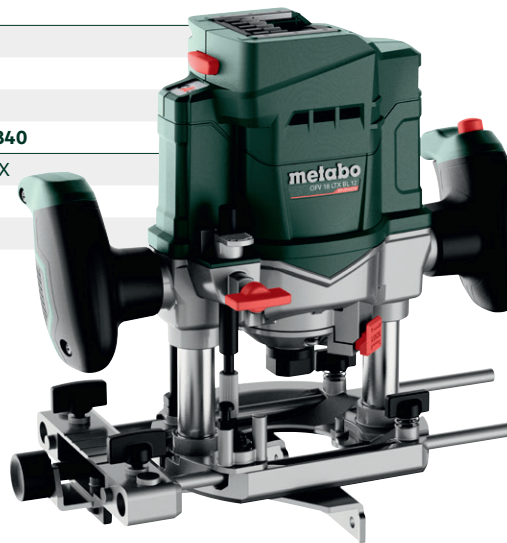

AKKU-MASCHINEN

2. Maschine auswählen

Sägen



**Säbelsäge
SSEP 18 LT**

Technische Daten	LT, Quick
Sägeblattthub	32 mm
Hubzahl bei Leerlauf	0 - 3'000 /min, Pendelhub
Service Gruppe	H02=135.00 / FS3=159.00
Bestell-Nr.	601616850
Verpackung	Karton
vRG inkl. MwSt	0.61
Preis inkl. MwSt/vRG	245.00
Bestell-Nr.	601616840
Verpackung	metaBOX
vRG inkl. MwSt	0.61
Preis inkl. MwSt/vRG	259.00



**Säbelsäge
SSEP 18 LT BL**

	BRUSHLESS
Technische Daten	LT, Quick
Sägeblattthub	32 mm
Hubzahl bei Leerlauf	2'700 /min
Service Gruppe	H02=135.00 / FS3=159.00
Bestell-Nr.	601617850
Verpackung	Karton
vRG inkl. MwSt	0.61
Preis inkl. MwSt/vRG	275.00
Bestell-Nr.	601617840
Verpackung	metaBOX
vRG inkl. MwSt	0.61
Preis inkl. MwSt/vRG	289.00



**Säbelsäge
SSE 18 LTX Compact**

Technische Daten	LTX, Quick
Sägeblattthub	13 mm
Hubzahl bei Leerlauf	3'100 /min
Service Gruppe	H01=69.00 / FS2=109.00
Bestell-Nr.	602266890
Verpackung	Karton
vRG inkl. MwSt	0.61
Preis inkl. MwSt/vRG	195.00
Bestell-Nr.	602266840
Verpackung	metaBOX
vRG inkl. MwSt	0.61
Preis inkl. MwSt/vRG	209.00



**Säbelsäge
SSE 18 LTX BL Compact**

	BRUSHLESS
Technische Daten	LTX, Quick
Sägeblattthub	13 mm
Hubzahl bei Leerlauf	3'100 /min
Service Gruppe	H02=135.00 / FS3=159.00
Bestell-Nr.	602366850
Verpackung	Karton
vRG inkl. MwSt	0.61
Preis inkl. MwSt/vRG	265.00
Bestell-Nr.	602366840
Verpackung	metaBOX
vRG inkl. MwSt	0.61
Preis inkl. MwSt/vRG	279.00



**Säbelsäge
SSEP 18 LTX BL MVT**

	BRUSHLESS
Technische Daten	LTX, Quick
Sägeblattthub	32 mm
Hubzahl bei Leerlauf	0 - 3.000 /min
Service Gruppe	H02=135.00 / FS4=215.00
Bestell-Nr.	602258850
Verpackung	Karton
vRG inkl. MwSt	0.61
Preis inkl. MwSt/vRG	425.00
Bestell-Nr.	602258840
Verpackung	metaBOX
vRG inkl. MwSt	0.61
Preis inkl. MwSt/vRG	449.00

Sägen



**Stichsäge
ST 18 L 90**

Technische Daten	L, Quick
Sägeblatthub	90 mm
Hubzahl bei Leerlauf	750 - 3'000 /min
Service Gruppe	H01=69.00 / FS1=55.00
Bestell-Nr.	601047850
Verpackung	Karton
vRG inkl. MwSt	0.61
Preis inkl. MwSt/vRG	165.00
Bestell-Nr.	601047840
Verpackung	metaBOX
vRG inkl. MwSt	0.61
Preis inkl. MwSt/vRG	179.00



**Stichsäge
ST 18 LT 130 BL**

	BRUSHLESS
Technische Daten	LT, Quick
Sägeblatthub	130 mm
Hubzahl bei Leerlauf	1'000 - 3'500 /min
Service Gruppe	H02=135.00 / FS2=109.00
Bestell-Nr.	601054850
Verpackung	Karton
vRG inkl. MwSt	0.61
Preis inkl. MwSt/vRG	255.00
Bestell-Nr.	601054840
Verpackung	metaBOX
vRG inkl. MwSt	0.61
Preis inkl. MwSt/vRG	269.00



**Stichsäge
STA 18 LTX 150 BL**

	BRUSHLESS
Technische Daten	LTX, Quick
Sägeblatthub	150 mm
Hubzahl bei Leerlauf	1'000-3'500 /min
Service Gruppe	H02=135.00 / FS4=215.00
Bestell-Nr.	601502850
Verpackung	Karton
vRG inkl. MwSt	0.61
Preis inkl. MwSt/vRG	365.00
Bestell-Nr.	601502840
Verpackung	metaBOX
vRG inkl. MwSt	0.61
Preis inkl. MwSt/vRG	389.00



**Multitool
MT 18 LTX**

Technische Daten	LTX, Quick
Schwingzahl bei Leerlauf	7'000-18'000 /min
Oszillationswinkel links/rechts	1.6°
Service Gruppe	H02=135.00 / FS3=159.00
Bestell-Nr.	613021890
Verpackung	Karton
vRG inkl. MwSt	0.61
Preis inkl. MwSt/vRG	245.00
Bestell-Nr.	613021840
Verpackung	metaBOX
vRG inkl. MwSt	0.61
Preis inkl. MwSt/vRG	259.00



**Multitool
MT 18 LTX BL QSL**

	BRUSHLESS
Technische Daten	LTX, Quick
Schwingzahl bei Leerlauf	Starlock & Starlock Plus
Oszillationswinkel links/rechts	1.6°
Service Gruppe	H02=135.00 / FS3=159.00
Bestell-Nr.	613088850
Verpackung	Karton
vRG inkl. MwSt	0.61
Preis inkl. MwSt/vRG	295.00
Bestell-Nr.	613088840
Verpackung	metaBOX
vRG inkl. MwSt	0.61
Preis inkl. MwSt/vRG	309.00



AKKU-MASCHINEN

2. Maschine auswählen

Sägen



**Handkreissäge
KS 18 LTX 57 BL**

BRUSHLESS

Technische Daten

LTX
57mm, Ø 165 x 20mm
+ FS 160

Service Gruppe

H02=135.00 / FS4=215.00

Bestell-Nr.

611857850

Verpackung

Karton

vRG inkl. MwSt

0.61

Preis inkl. MwSt/vRG

325.00

Bestell-Nr.

611857840

Verpackung

metaBOX

vRG inkl. MwSt

0.61

Preis inkl. MwSt/vRG

339.00



**Handkreissäge
KS 18 LTX 66 BL**

BRUSHLESS

LTX
66mm, Ø 165 x 20mm

H02=135.00 / FS4=215.00

611866850

Karton

2.50

425.00

611866840

metaBOX

2.50

449.00



**Handkreissäge
KS 18 LTX 66 BL Set**

BRUSHLESS

LTX
66mm, Ø 165 x 20mm

+ KFS 44

H02=135.00 / FS4=215.00

691194000

metaBOX

2.50

589.00



**Tauchkreissäge
KT 18 LTX 66 BL**

BRUSHLESS

Technische Daten

LTX
66mm, Ø 165 x 20mm

Service Gruppe

H03=189.00 / FS4=215.00

Bestell-Nr.

601866840

Verpackung

metaBOX

vRG inkl. MwSt

2.50

Preis inkl. MwSt/vRG

619.00



**Tauchkreissäge
KT 18 LTX 66 BL Set**

BRUSHLESS

LTX
66mm, Ø 165 x 20mm

+ FS 160

H03=189.00 / FS4=215.00

691172840

metaBOX

2.50

719.00

PICK+MIX 18V

Sägen



**Kapp- und Gehrungssäge
KGS 18 LTX BL 216**

BRUSHLESS

Technische Daten

LTX
305 / 215 mm / 70 / 40 mm
Ø 216 x 30 mm, 5'000 /min

Service Gruppe

H02=135.00 / FS4=215.00

Bestell-Nr.

614216850

Verpackung

Karton

vRG inkl. MwSt

2.50

Preis inkl. MwSt/vRG

419.00

**Kapp- und Gehrungssäge
KGS 18 LTX BL 254**

BRUSHLESS

LTX
305 / 215 mm / 92 / 47 mm
Ø 254 x 30 mm, 4'000 /min

H03=189.00 / FS4=215.00

614254850

Karton

2.50

569.00

**Kapp- und Gehrungssäge
KGS 18 LTX BL 305**

BRUSHLESS

LTX
305 / 215 mm / 110 / 67 mm
Ø 305 x 30 mm, 3'700 /min

H03=189.00 / FS4=215.00

614305850

Karton

6.01

719.00



**Tischkreissäge
TS 36-18 LTX BL 254**

BRUSHLESS

Technische Daten

LTX
87 mm
Ø 254 x 30 mm

Service Gruppe

000 / keine

Bestell-Nr.

613025850

Verpackung

Karton

vRG inkl. MwSt

10.81

Preis inkl. MwSt/vRG

1'029.00





AKKU-MASCHINEN



2. Maschine auswählen

Saugen



	Sauger AS 18 L PC Compact 	Sauger AS 18 HEPA PC Compact 	Sauger AS 18 L PC 
Behältervolumen	6 l, Klasse L	6 l, Klasse H	7.5 l, Klasse L
Luftleistung max	2'100l/min	2'100l/min	2'100l/min
Unterdruck	120hPa (mbar)	120hPa (mbar), HEPA Filter	120hPa (mbar)
Service Gruppe	H01=69.00 / FS2=109.00	H01=69.00 / FS2=109.00	H02=135.00 / FS4=215.00
Bestell-Nr.	602028850	602029850	602021850
Verpackung	Karton	Karton	Karton
vRG inkl. MwSt	0.61	0.61	0.61
Preis inkl. MwSt/vRG	159.00	169.00	249.00



	Sauger + Rollbrett AS 18 L PC set 	Sauger ASR 36-18 BL 25 M SC  BRUSHLESS	Sauger AS 36-18 L 20 PC 
Behältervolumen	7.5 l, Klasse L	25 l, Klasse M	20 l, Klasse L
Luftleistung max	2'100l/min	4'000l/min	3'300 l/min
Unterdruck	120 hPa (mbar)	240 hPa (mbar)	140 hPa (mbar)
Service Gruppe	H01=69.00 / Keine	H04=269.00 / FS4=215.00	H02=135.00 / FS4=215.00
Bestell-Nr.	691060000	602046850	602071850
Verpackung	Karton	Karton	Karton
vRG inkl. MwSt	0.610	2.50	2.50
Preis inkl. MwSt/vRG	309.00	1'239.00	319.00

PICK+MIX 18V

Saugen



Sauger
AS 36-18 L 20 PC CC



Behältervolumen	20 l, Klasse L
Luftleistung max	3'300 l/min
Unterdruck	140 hPa (mbar)
Service Gruppe	H02=135.00 / FS4=215.00
Bestell-Nr.	602072850
Verpackung	Karton
vRG inkl. MwSt	2.50
Preis inkl. MwSt/vRG	419.00



Sauger
AS 36-18 L 30 PC CC



Behältervolumen	30 l, Klasse L
Luftleistung max	3'300 l/min
Unterdruck	140 hPa (mbar)
Service Gruppe	H02=135.00 / FS4=215.00
Bestell-Nr.	602073850
Verpackung	Karton
vRG inkl. MwSt	2.50
Preis inkl. MwSt/vRG	479.00



Sauger
AS 36-18 M 30 PC CC



Behältervolumen	30 l, Klasse M
Luftleistung max	3'300 l/min
Unterdruck	140 hPa (mbar)
Service Gruppe	H03=189.00 / FS4=215.00
Bestell-Nr.	602074850
Verpackung	Karton
vRG inkl. MwSt	2.50
Preis inkl. MwSt/vRG	559.00

Sauger
AS 36-18 H 30 PC CC



Behältervolumen	30 l, Klasse H
Luftleistung max	3'300 l/min
Unterdruck	140 hPa (mbar)
Service Gruppe	H03=189.00 / FS4=215.00
Bestell-Nr.	602075850
Verpackung	Karton
vRG inkl. MwSt	2.50
Preis inkl. MwSt/vRG	639.00



AKKU-MASCHINEN

2. Maschine auswählen

Metallbearbeitung



NEW

Bandfeile
BFVB 18 LTX BL 90

BRUSHLESS

Technische Daten

LTX
457 mm
Schleifbandbreite 6-19 mm

Service Gruppe

H03=189.00 / FS4=215.00

Bestell-Nr.

601767840

Verpackung

Karton

vRG inkl. MwSt

0.61

Preis inkl. MwSt/vRG

629.00



NEW

Kehlnahtschleifer
KNSVB 18 LTX BL 150

BRUSHLESS

LTX
150 mm
1.000-3.600 /min
H03=189.00 / FS4=215.00

601765840

Karton

0.61

799.00



NEW

Satiniermaschine
SVB 18 LTX BL 200

BRUSHLESS

LTX
600-2.500 /min
Schleifkörper Ø 200 mm
H03=189.00 / FS4=215.00

601766840

Karton

0.61

659.00



NEW

Rohrbandschleifer
RBVB 18 LTX BL 180

BRUSHLESS

Technische Daten

LTX
270°
40 mm / 760 mm / 180 mm

Service Gruppe

H03=189.00 / FS4=215.00

Bestell-Nr.

601768840

Verpackung

Karton

vRG inkl. MwSt

0.61

Preis inkl. MwSt/vRG

999.00



Blechscherer
SCV 18 LTX BL 1.6

BRUSHLESS

LTX
1'350 - 4'840 /min
1.6mm für Flachblech
H03=189.00 / FS4=215.00

601615850

Karton

0.61

645.00

601615840

metaBOX

0.61

669.00



Nibbler
NIV 18 LTX BL 1.6

BRUSHLESS

LTX
660 - 2'360 /min
1.6mm für Wellbleche
H03=189.00 / FS4=215.00

601614850

Karton

0.61

645.00

601614840

metaBOX

0.61

669.00

Metallbearbeitung



**Geradschleifer
GVB 18 LTX BL 11-28**

BRUSHLESS

Technische Daten	LTX
	8'000 - 28'000 /min
	6 mm Spannzange
Service Gruppe	H02=135.00 / FS4=215.00
Bestell-Nr.	600826850



**Geradschleifer
GVB 18 LTX BL 11-7 HT**

BRUSHLESS

Technische Daten	LTX
	1'500 - 7'000 /min
	6 mm Spannzange
Service Gruppe	H02=135.00 / FS4=215.00
Bestell-Nr.	600829850

Verpackung	Karton
vRG inkl. MwSt	0.61
Preis inkl. MwSt/vRG	345.00
Bestell-Nr.	600826840
Verpackung	metaBOX
vRG inkl. MwSt	0.61
Preis inkl. MwSt/vRG	359.00

NEW

**Metall-Handkreissäge
MKS 18 LTX BL 58**

BRUSHLESS

Technische Daten	LTX
	58mm, Ø 165 x 20mm
	für Metall
Service Gruppe	H02=135.00 / FS4=215.00
Bestell-Nr.	600773840

Verpackung	metaBOX
vRG inkl. MwSt	0.61
Preis inkl. MwSt/vRG	449.00



AKKU-MASCHINEN

2. Maschine auswählen

Schleifen / Hobeln / Nageln



	Hobel HO 18 LTX 20-82	Schwingschleifer SM 18 LTX BL BRUSHLESS	Exzentrerschleifer SXA 18 LTX 125 BL BRUSHLESS
Technische Daten	LTX 0-2 mm 82 mm	LTX 4'000 - 10'000 /min 100 x 150 mm, 2 mm	LTX 4'000 - 12'000 /min Ø 125 mm
Service Gruppe	H02=135.00 / FS4=215.00	H02=135.00 / FS3=159.00	H02=135.00 / FS3=159.00
Bestell-Nr.	602082890	602089850	600146850
Verpackung	Karton	Karton	Karton
vRG inkl. MwSt	0.61	0.61	0.61
Preis inkl. MwSt/vRG	265.00	285.00	285.00
Bestell-Nr.	602082840	602089840	600146840
Verpackung	metaBOX	metaBOX	metaBOX
vRG inkl. MwSt	0.61	0.61	0.61
Preis inkl. MwSt/vRG	279.00	299.00	299.00



	Exzentrerschleifer SXA 18 LTX 150 BL BRUSHLESS	Nagler NFR 18 LTX 90 BL BRUSHLESS
Technische Daten	LTX 4'000 - 10'000 /min Ø 150 mm	LTX 50 - 90 mm Ø 2,9 - 3,3 mm, 2 /s, 30 - 34 °
Service Gruppe	H02=135.00 / FS3=159.00	H03=189.00 / FS4=215.00
Bestell-Nr.	600411850	
Verpackung	Karton	
vRG inkl. MwSt	0.61	
Preis inkl. MwSt/vRG	315.00	
Bestell-Nr.	600411840	612090840
Verpackung	metaBOX	metaBOX
vRG inkl. MwSt	0.61	0.61
Preis inkl. MwSt/vRG	329.00	699.00



PICK+MIX 18V

Optimales Licht



NEW



	Baustrahler BSA 18-1000	Baustrahler BSA 12-18 LED 2000	Baustrahler BSA 18 LED 4000
Technische Daten	1000 lm	2000 lm	4000 lm
		75 min pro Ah (18 V) 41 min pro Ah (12 V)	35 min pro Ah (LiHD 18 V)
Service Gruppe	Keine / FS1=55.00	H01=69.00 / FS1=55.00	H02=135.00 / FS2=109.00
Bestell-Nr.	601508850	601504850	601505850
Verpackung	Karton	Karton	Karton
vRG inkl. MwSt	0.19	0.19	0.19
Preis inkl. MwSt/vRG	89.00	139.00	209.00



	Beleuchtung SLA 14.4-18 LED	Beleuchtung ULA 14.4-18 LED
Technische Daten	440 lm	280 lm
	0.5 kg	0.4 kg
Service Gruppe	Keine / FS1=55.00	Keine / FS1=55.00
Bestell-Nr.	600370000	600368000
Verpackung	Karton	Karton
vRG inkl. MwSt	0.19	0.19
Preis inkl. MwSt/vRG	69.00	69.00

	Baustrahler BSA 18 LED 5000 DUO-S
Technische Daten	5000 lm
	25 min / Ah (LiHD 18 V)
Service Gruppe	H02=135.00 / FS2=109.00
Bestell-Nr.	601507850
Verpackung	Karton
vRG inkl. MwSt	0.19
Preis inkl. MwSt/vRG	289.00



AKKU-MASCHINEN

2. Maschine auswählen

Heckenscheren



	Heckenscherer HS 18 LTX 45	Heckenscherer HS 18 LTX 55	Heckenscherer HS 18 LTX 65
	18 V	18 V	18 V
Technische Daten	LTX	LTX	LTX
Schnittlänge	430 mm	530 mm	630 mm
Schnittstärke, Schnittzahl bei Leerlauf	19 mm, 2'600/min, Bremse	19 mm, 2'600/min, Bremse	19 mm, 2'600/min, Bremse
Service Gruppe	H01=69.00 / FS2=109.00	H01=69.00 / FS2=109.00	H01=69.00 / FS2=109.00
Bestell-Nr.	601717850	601718850	601719850
Verpackung	Karton	Karton	Karton
vRG inkl. MwSt	0.61	0.61	0.61
Preis inkl. MwSt/vRG	149.00	159.00	169.00



	Heckenscherer HS 18 LTX BL 55	Heckenscherer HS 18 LTX BL 65	Heckenscherer HS 18 LTX BL 75
	18 V	18 V	18 V
Technische Daten	LTX	LTX	LTX
Schnittlänge	500 mm	600 mm	700 mm
Schnittstärke, Schnittzahl bei Leerlauf	21 mm, 3'400/min, Bremse	21 mm, 3'400/min, Bremse	21 mm, 3'400/min, Bremse
Service Gruppe	H02=135.00 / FS4=215.00	H02=135.00 / FS4=215.00	H02=135.00 / FS4=215.00
Bestell-Nr.	601722850	601723850	601724850
Verpackung	Karton	Karton	Karton
vRG inkl. MwSt	0.61	0.61	0.61
Preis inkl. MwSt/vRG	289.00	309.00	329.00

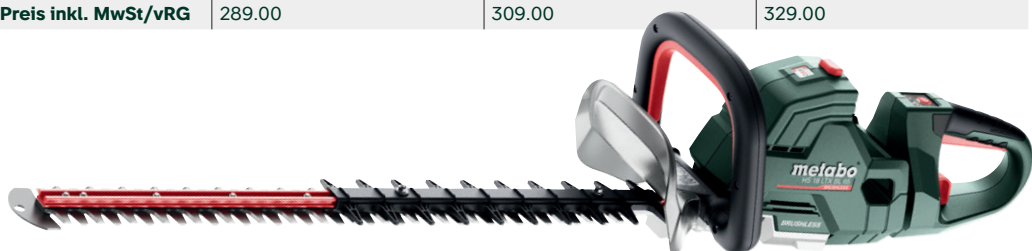

Gartengeräte

Kettensäge MS 36-18 LTX BL 40 2 x 18 V **BRUSHLESS**

Technische Daten	LTX
Schnittlänge	360 mm
Kettengeschwindigkeit	22 m/s / 3,2 kg
Service Gruppe	H02=135.00 / FS4=215.00
Bestell-Nr.	601613850
Verpackung	Karton
vRG inkl. MwSt	0.61
Preis inkl. MwSt/vRG	369.00



Rasentrimmer RTD 18 LTX BL 30 18 V **BRUSHLESS**

Technische Daten	LTX
Schnittkreis-Ø	Ø 300 mm
Handgriff	Rundgriff
Service Gruppe	H02=135.00 / FS3=159.00
Bestell-Nr.	601720850

Verpackung	Karton
vRG inkl. MwSt	0.61
Preis inkl. MwSt/vRG	209.00



Freischneider FSD 36-18 LTX BL 40 2 x 18 V **BRUSHLESS**

Technische Daten	LTX
Schnittkreis-Ø	Ø 400 mm
Handgriff	Rundgriff
Service Gruppe	H02=135.00 / FS4=215.00
Bestell-Nr.	601610850

Verpackung	Karton
vRG inkl. MwSt	0.61
Preis inkl. MwSt/vRG	339.00



Freischneider FSB 36-18 LTX BL 40 2 x 18 V **BRUSHLESS**

Technische Daten	LTX
Schnittkreis-Ø	Ø 400 mm
Handgriff	Bikehandgriff
Service Gruppe	H02=135.00 / FS4=215.00
Bestell-Nr.	601611850

Verpackung	Karton
vRG inkl. MwSt	0.61
Preis inkl. MwSt/vRG	419.00

Gartengeräte



	Heckenscheren-Aufsatz MA-HS 50	Hochtaster-Aufsatz MA-MS 25	Freischneider-Aufsatz MA-FS 40
	18 V	18 V	18 V
Technische Daten	48 cm	LTX	LTX
	22 mm	16 m/s / 18 m/s, 24 mm	400 mm
Gewicht	2,8 kg	1,7 kg	1,6 kg
Service Gruppe	H01=69.00 / FS2=109.00	H01=69.00 / FS1=55.00	H01=69.00 / FS1=55.00
Bestell-Nr.	601726850	601727850	601728850
Verpackung	Karton	Karton	Karton
vRG inkl. MwSt	0.61	0.61	0.61
Preis inkl. MwSt/vRG	199.00	199.00	129.00

Multifunktions-Antrieb MA 36-18 LTX BL Q

18 V BRUSHLESS

Technische Daten	LTX
Leerlaufdrehzahlen	0-7.000 / 0-8.200/min
Griff	Rundgriff
Service Gruppe	H02=135.00 / FS3=159.00
Bestell-Nr.	601725850
Verpackung	Karton
vRG inkl. MwSt	0.61
Preis inkl. MwSt/vRG	259.00



Gartengeräte



**Gehölzsäge
MS 18 LTX 15**

18 V

Technische Daten

LTX

15 cm

Gewicht

1,6 kg

Service Gruppe

H01=69.00 / FS1=55.00

Bestell-Nr.

600856850

Verpackung

Karton

vRG inkl. MwSt

0.61

Preis inkl. MwSt/vRG

159.00

Bestell-Nr.

600856840

Verpackung

metaBOX

vRG inkl. MwSt

0.61

Preis inkl. MwSt/vRG

179.00



**Strauch- Grasschere
SGS 18 LTX Q**

18 V

LTX

200 mm / 80 mm / 115 mm

0.8 kg

H01=69.00 / FS1=55.00

601609850

Karton

0.61

129.00

601609840

metaBOX

0.61

149.00



**Rückensprüngerät
RSG 18 LTX 15**

18 V

LTX

0.3-1.9 l/min (1-3 bar), 15 L

4 kg

H02=135.00 / FS4=215.00

602038850

Karton

2.5

499.00



**Gebläse
AG 18**

18 V

Technische Daten

74 m/s

2.6 m³/min

1,4 kg

Service Gruppe

H01=69.00 / FS1=55.00

Bestell-Nr.

602242850

Verpackung

Karton

vRG inkl. MwSt

0.61

Preis inkl. MwSt/vRG

129.00



**Laubbläser
LB 18 LTX BL**

18 V BRUSHLESS

LTX

150 km/h

bis zu 40 min Laufzeit

H02=135.00 / FS2=109.00

601607850

Karton

0.61

209.00



GARTENGERÄTE

2. Maschine auswählen

Tauchpumpen



	Tauchpumpe TPF 18 LTX 2200	Tauchpumpe TPF 18 LTX 7000
	18 V	18 V
Technische Daten	LTX	LTX
Fördermenge, -höhe	2'200 l/h, 22 m 2,2 bar, 1-2 mm, 2,1 kg	7'000 l/h, 9 mm 0,9 bar 1-2 mm, 2,4 kg
Service Gruppe	H01=69.00 / FS1=55.00	H01=69.00 / FS1=55.00
Bestell-Nr.	601729850	601748850
Verpackung	Karton	Karton
vRG inkl. MwSt	0.61	0.61
Preis inkl. MwSt/vRG	119.00	139.00



PICK+MIX 18V

Rasenmäher



Rasenmäher
RM 36-18 LTX BL 36
2 x 18 V **BRUSHLESS**

Technische Daten	LTX
Schnittbreite	Ø 360 mm
Fangsackvolumen	45 L, 95 dB
Service Gruppe	H02=135.00 / FS4=215.00
Bestell-Nr.	601716850
Verpackung	Karton
vRG inkl. MwSt	2.50
Preis inkl. MwSt/vRG	289.00

Rasenmäher
RM 36-18 LTX BL 46
2 x 18 V **BRUSHLESS**

Technische Daten	LTX
Schnittbreite	Ø 460 mm
Fangsackvolumen	55 L, 96 dB
Service Gruppe	H03=189.00 / FS4=215.00
Bestell-Nr.	601606850
Verpackung	Karton
vRG inkl. MwSt	2.50
Preis inkl. MwSt/vRG	569.00



GARTENGERÄTE

2. Maschine auswählen

Zusatzgeräte



	Klebepistole HK 18 LTX 20	Rührwerk RW 18 LTX BL 120 BRUSHLESS	Rührwerk RW 18 LTX BL 140-2 BRUSHLESS
Technische Daten	LTX 20 g/min 200 / 130 °C, 11 mm Ø	LTX 120mm, 30 l, 3,4 kg IG / M14	LTX 140mm, 50 l, 4,2 kg IG / M14
Service Gruppe	Keine / FS1=55.00	H02=135.00 / FS3=159.00	H02=135.00 / FS4=215.00
Bestell-Nr.	600797850	601164850	601165850
Verpackung	Karton	Karton	Karton
vRG inkl. MwSt	0.61	0.61	0.61
Preis inkl. MwSt/vRG	89.00	289.00	329.00
Bestell-Nr.	600797840		
Verpackung	metaBOX		
vRG inkl. MwSt	0.61		
Preis inkl. MwSt/vRG	109.00		



	Ventilator AV 18	Adapter PA 14.4-18 LED-USB	Heissluftgebläse HG 18 LTX 500
Technische Daten	3.8 m/s bis zu 7 Stunden Laufzeit	14.4 - 18 V USB LED-licht 12V-HJA	LTX 300/500 °C Einsatzbereit <5 Sec.
Service Gruppe	H01=69.00 / FS1=55.00	Keine / FS1=55.00	H02=135.00 / FS2=109.00
Bestell-Nr.	606176850	600288000	610502850
Verpackung	Karton	Karton	Karton
vRG inkl. MwSt	0.61	0.20	0.61
Preis inkl. MwSt/vRG	129.00	49.00	225.00
Bestell-Nr.			610502840
Verpackung			metaBOX
vRG inkl. MwSt			0.61
Preis inkl. MwSt/vRG			239.00

Zusatzgeräte



**Fettpresse
FP 18 LTX**

Technische Daten	LTX 690 / 413 bar 100 / 290 g/min
Service Gruppe	H02=135.00 / FS4=215.00
Bestell-Nr.	600789850
Verpackung	Karton
vRG inkl. MwSt	0.61
Preis inkl. MwSt/vRG	399.00



**Kartuschenpistole
KPA 18 LTX 400**

Technische Daten	LTX 400 ml 7259N, Kartuschenträger
Service Gruppe	H02=135.00 / FS4=215.00
Bestell-Nr.	601206850
Verpackung	Karton
vRG inkl. MwSt	0.61
Preis inkl. MwSt/vRG	419.00



**Kartuschenpistole
KPA 18 LTX 600**



**Blaspistole
BP 18 LTX BL**

BRUSHLESS

Technische Daten	LTX 0,7 m ³ /min, 122 m/s, 0,4 kg Hält Maschinen und Arbeitsplatz sauber
Service Gruppe	H01=69.00 / FS1=55.00
Bestell-Nr.	600798850
Verpackung	Karton
vRG inkl. MwSt	0.61
Preis inkl. MwSt/vRG	119.00



**Kompressor
AK 18 Multi**

Technische Daten	11 bar 16l/min, 2,6 kg
Service Gruppe	H01=69.00 / FS1=55.00
Bestell-Nr.	600794850
Verpackung	Karton
vRG inkl. MwSt	0.61
Preis inkl. MwSt/vRG	189.00



**Kompressor
Power 160-5 18 LTX BL OF**

BRUSHLESS

Technische Daten	LTX 8 bar 70l/min, 5l, Ölfrei
Service Gruppe	H02=135.00 / Keine
Bestell-Nr.	601521850
Verpackung	Karton
vRG inkl. MwSt	2.50
Preis inkl. MwSt/vRG	289.00

2. Maschine auswählen

Zusatzgeräte



**Kühlbox
KB 18**



**Baustellenradio
R 12-18 DAB BT**



**Baustellenradio
RC 12-18 32W BT DAB+**

Technische Daten	Max. Kühlleistung unter Umgebungstemperatur 17 °C Max. Warmhaltetemperatur 60 °C, Volume 24 l, 5,9 kg	DAB+, FM/AM Bluetooth, Netzkabel	DAB+, FM/AM Bluetooth, mit Akku-Ladefunktion
Service Gruppe	H01=69.00 / FS1=55.00	H01=69.00 / FS1=55.00	H02=135.00 / FS4=215.00
Bestell-Nr.	600791850	600778850	600779180
Verpackung	Karton	Karton	Karton
vRG inkl. MwSt	0.61	0.61	2.50
Preis inkl. MwSt/vRG	159.00	159.00	409.00



3. Transportlösung auswählen

MetaBOX



	metaBOX 118	metaBOX 145	metaBOX 145 M
Technische Daten	396 x 296 x 118 mm	396 x 296 x 145 mm	446 x 346 x 145 mm
Bestell-Nr.	626882000	626883000	626907000
Verpackung	leer	leer	leer
Preis inkl. MwSt/vRG	36.50	38.00	56.50
Bestell-Nr.	626885000	626886000	
Verpackung	BS/SB 12 V	BS/SB L/LT18V	
Preis inkl. MwSt/vRG	36.50	38.00	



	metaBOX 145 L	metaBOX 165 L	metaBOX 185 XL
Technische Daten	496 x 296 x 145 mm	496 x 296 x 165 mm	596 x 396 x 185 mm
Bestell-Nr.	626884000	626889000	626901000
Verpackung	leer	leer	KH 18 LTX BL 24/28 Q Set
Preis inkl. MwSt/vRG	39.50	40.50	98.00
Bestell-Nr.	626891000	626890000	
Verpackung	BS/SB LTX 18V	Winkelschleifer	
Preis inkl. MwSt/vRG	39.50	40.50	
Bestell-Nr.	626892000		
Verpackung	SBE/KHE/UHE		
Preis inkl. MwSt/vRG	39.50		



	metaBOX 215	metaBOX 280L Organizer	metaBOX 340
Technische Daten	396 x 296 x 215 mm	496 x 296 x 280 mm	396 x 296 x 340 mm
Bestell-Nr.	626887000	626964000	626888000
Verpackung	leer	leer	leer
Preis inkl. MwSt/vRG	43.50	77.50	51.00

3. Transportlösung auswählen

MetaBOX



metaBOX 145
Toolbox

Technische Daten	396 x 296 x 153.5 mm
Bestell-Nr.	626908000
Preis inkl. MwSt/vRG	51.00



metaBOX 340
Toolbox

Technische Daten	396 x 296 x 348.5 mm
Bestell-Nr.	626909000
Preis inkl. MwSt/vRG	67.00



metaBOX 63 XS
Organiser

Technische Daten	252 x 167 x 63 mm
Bestell-Nr.	626896000
Preis inkl. MwSt/vRG	26.00



metaBOX 118
Organiser

Technische Daten	396 x 296 x 118 mm
Bestell-Nr.	626897000
Preis inkl. MwSt/vRG	71.00



metabOX
Rollbrett

Technische Daten	bis 100 kg
Bestell-Nr.	626894000
Preis inkl. MwSt/vRG	91.50



metaBOX
Adapterplatte

Technische Daten	Sortimo Fahrzeugeinrichtungen Globelyst und SR5
Bestell-Nr.	626895000
Preis inkl. MwSt/vRG	25.00



metaBOX
Multi- Adapterplatte

Technische Daten	Zur Fixierung aller gängigen Werkzeugbox-Systeme auf der metaBOX
Bestell-Nr.	626900000
Preis inkl. MwSt/vRG	36.00

Werkzeugtaschen / Zubehör



Werkzeugtasche klein

460 x 260 x 280 mm

Technische Daten

Bestell-Nr.

657006000

Preis inkl. MwSt/vRG

45.50



Werkzeugtasche gross

670 x 290 x 325 mm

657007000

69.00



metaBOX Sackkarre

bis 125 kg,
auf Treppen 50 kg

626893000

177.00



NEW



Metabo Tracker

Immer wissen, wo dein Werkzeug ist. Für iPhone, iPad, Apple Watch oder Mac

Technische Daten

Bestell-Nr.

626965000

Preis inkl. MwSt/vRG

45.00

Das Werkzeug immer im Blick.

NEU

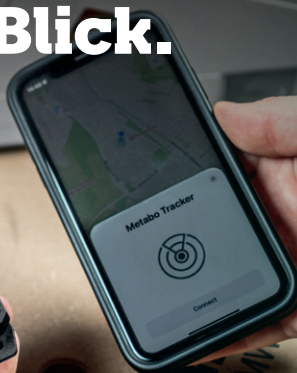

AKKU-ZUBEHÖR

Akku-Maschinen im Set

Akku-Maschinen im Set



Comboset 2.1.15

Li HD

BRUSHLESS

Lieferumfang	SB 18 LTX BL I + SSD 18 LTX 200 BL
Ladegerät	ASC 145
Batterien	2 x LiHD 5.5 Ah
Bestell-Nr.	685184000
Verpackung	metaBOX 145 L
vRG inkl. MwSt	5.96
Preis inkl. MwSt/vRG	699.00

Comboset 2.2.5

Lieferumfang	BS 18 + SGS 18 LTX Q
Ladegerät	SC 30
Batterien	2 x 2.0 Ah
Bestell-Nr.	685186000
Verpackung	metaBOX 165 L
vRG inkl. MwSt	5.96
Preis inkl. MwSt/vRG	269.00

Comboset 2.3.2

Lieferumfang	BS 18 + KH 18 LTX 24
Ladegerät	SC 30
Batterien	2 x 2.0 Ah
Bestell-Nr.	685216500
Verpackung	metaBOX 165 L
vRG inkl. MwSt	5.96
Preis inkl. MwSt/vRG	365.00



Comboset 2.3.6

Li HD

BRUSHLESS

Lieferumfang	BS 18 LT BL + KH 18 LTX BL 24
Ladegerät	ASC 55
Batterien	2 x LiHD 4.0 Ah
Bestell-Nr.	685218800
Verpackung	metaBOX 340
vRG inkl. MwSt	5.96
Preis inkl. MwSt/vRG	639.00

Comboset 2.4.1

Lieferumfang	BS 18 LT + W 18 L 9-125 Quick
Ladegerät	ASC 55
Batterien	2 x 4.0 Ah
Bestell-Nr.	685206510
Verpackung	metaBOX 165 L
vRG inkl. MwSt	5.96
Preis inkl. MwSt/vRG	499.00

Comboset 2.4.2

Lieferumfang	SB 18 LT + W18 L 9-125 Quick
Ladegerät	ASC 55
Batterien	2 x 4.0 Ah
Bestell-Nr.	685207510
Verpackung	metaBOX 165 L
vRG inkl. MwSt	5.96
Preis inkl. MwSt/vRG	499.00

Akku-Maschinen im Set

Comboset 2.4.4

Comboset 2.4.8

Comboset 2.5.2

		BRUSHLESS	BRUSHLESS
Lieferumfang	SB 18 + W 18 L 9-125	BS 18 LT BL + KH 18 LTX BL 24 Quick	BS 18 LT BL + BH 18 LTX BL 16
Ladegerät	SC 30	ASC 55	ASC 55
Batterien	1 x 2.0 Ah + 1 x 4.0 Ah	2 x 5.2 Ah	1 x 2.0 Ah + 1 x 4.0 Ah
Bestell-Nr.	685205500	685219650	685182000
Verpackung	metaBOX 165 L	metaBOX 340	metaBOX 145 L
vRG inkl. MwSt	5.96	5.96	5.96
Preis inkl. MwSt/vRG	349.00	679.00	509.00

Comboset 2.6.5

Comboset 2.6.6

Comboset 2.8.4

	BRUSHLESS		BRUSHLESS
Lieferumfang	BS 18 L BL + W 18 L BL 9-125	BS 18 + W 18 7-125	BS 18 LT BL + SSD 18 LT 200 BL
Ladegerät	ASC 30	ASC 30	ASC 55
Batterien	1 x 2.0 Ah + 1 x 4.0 Ah	1 x 2.0 Ah + 1 x 4.0 Ah	2 x 5.2 Ah
Bestell-Nr.	685233000	685234000	685196000
Verpackung	metaBOX 165 L	metaBOX 165 L	metaBOX 145 L
vRG inkl. MwSt	2.33	2.33	5.96
Preis inkl. MwSt/vRG	439.00	319.00	489.00

Akku-Maschinen im Set

Akku-Maschinen im Set



Combo set 2.9.3

Combo set 2.9.4

	BRUSHLESS	BRUSHLESS
Lieferumfang	BS 18 LT BL + SSW 18 LT 300 BL	BS 18 LT BL + WB 18 LT BL 11-125 Quick
Ladegerät	ASC 55	ASC 55
Batterien	2 x 5.2 Ah	2 x 5.2 Ah
Bestell-Nr.	685203000	685208650
Verpackung	metaBOX 145 L	metaBOX 165 L
vRG inkl. MwSt	5.96	5.96
Preis inkl. MwSt/vRG	519.00	579.00



Combo set 3.1.1

Combo set 4.3.2

	BRUSHLESS	Li HD BRUSHLESS
Lieferumfang	BS 18 L BL + CC 18 LTX BL + BH 18 LTX BL 16	BS 18 LTX BL I + SSW 18 LTX 400 BL + WB 18 LT BL 11-125 Q + BSA 18 LED 4000
Ladegerät	ASC 55	ASC 145
Batterien	2 x 4.0 Ah	2x LiHD 10.0Ah
Bestell-Nr.	685235000	685209000
Verpackung	Werkzeugtasche	Werkzeugtasche
vRG inkl. MwSt	5.96	11.22
Preis inkl. MwSt/vRG	629.00	1'029.00

Akku-Maschinen im Set



Bauhandwerk 3.1

BRUSHLESS

Lieferumfang

KH 18 LTX 24 +
W 18 L 9-125 Quick +
SB 18 LT BL

Ladegerät

ASC 55

Batterien

3 x 5.2 Ah

Bestell-Nr.

685212000

Verpackung

Werkzeugtasche

vRG inkl. MwSt

5.96

Preis inkl. MwSt/vRG

719.00



Bauhandwerk 4.3

BRUSHLESS

SB 18 LT BL +
W 18 L 9-125 Quick +
KH 18 LTX 24 +
STA 18 LTX 100

ASC 145

3 x 4.0 Ah

685214000

Werkzeugtasche

11.22

909.00



Bauhandwerk 5.2

BRUSHLESS

BS 18 LTX BL Impuls +
SSW 18 LTX 300 BL +
KH 18 LTX 24 +
W 18 L 9-125 Quick +
R12-18 DAB + BT

ASC 55

3 x 4.0 Ah

685213000

Werkzeugtasche

11.22

1'139.00

Bauhandwerk 6.1

BRUSHLESS

Lieferumfang

KH 18 LTX 24 +
SB 18 LTX Impuls +
SSW 18 LTX 300 BL +
W 18 L 9-125 Quick +
SSEP 18 LT +
ULA 14.4-18 LED

Ladegerät

ASC 55

Batterien

4 x 4.0 Ah

Bestell-Nr.

685211000

Verpackung

Werkzeugtasche

vRG inkl. MwSt

11.22

Preis inkl. MwSt/vRG

1'239.00





Mit verschiedenen Marken arbeiten? Einfach mit einem CAS Akku.



metabo

mafell

GESIPA®

PREBENA

SCANGRIP®
INNOVATION FROM DENMARK

MONTIPOWER
Surface Preparation Technologies
Part of Monti Group

TRUMPF

BAIER
Elektro-
werkzeuge

virax

EIBENSTOCK

Lamello

ITH-
Bolting Technology

starmix

CEMO

ROKAMAT
easy working

holmatro
mastering power

steinel

SPEWE +

JEPSON POWER
GERMANY
Leading Through Innovation

JOST
abrasives

Pressfit

STABILA

edding®

RICO
YOU WILL SEE.

LIEVERS
HOLLAND

STRAUSS

fischer

part of starmix
haaga

CEMBRE

RIEXINGER

BIRCHMEIER

RUBI

Collomix

pulsFOG

cleanfix

PROMOTECH®

EISENBLÄTTER

HellermannTyton

ENERPAC

ROTHENBERGER
pipetool technologies at work

SUNNER

ghibli & wirbel

NOVUS®



Services digital – Registrieren und profitieren!

APP

Alle Tools immer im Blick: Mit nur einer einfachen Registrierung per App oder Portal ganz einfach von zahlreichen Services, exklusiven Aktionen und weiteren Vorteilen profitieren.

JETZT APP DOWNLOADEN



Wenn Reparatur, dann einfach und schnell!

Mit der Metabo Smart Repair und den Reparaturfestpreisen bereits im Voraus wissen, was eine Reparatur kostet: Natürlich prüfen wir jede Maschine immer transparent und fair auf das Vorliegen eines Garantiefalls. Eines ist immer sicher – eine schnelle Reparatur innerhalb von 24h.



Schon gewusst?

Egal ob LiHD- oder Li-Power-Akkupacks von Metabo: Wir gewähren 3 Jahre Garantie gratis auf alle Akkupacks und Ladegeräte – ohne Beschränkung der Ladezyklen. Eine Registrierung ist nicht notwendig.